



BON DE COMMANDE VERANDA

N°

N° référence client

Date

Nom du client :

Prénom

Adresse

N° Tél domicile

N° Tél bureau :

Lieu de livraison :

Remplir obligatoirement 1 bon de commande par produit

Dimensions 1 travée - 1 moteur

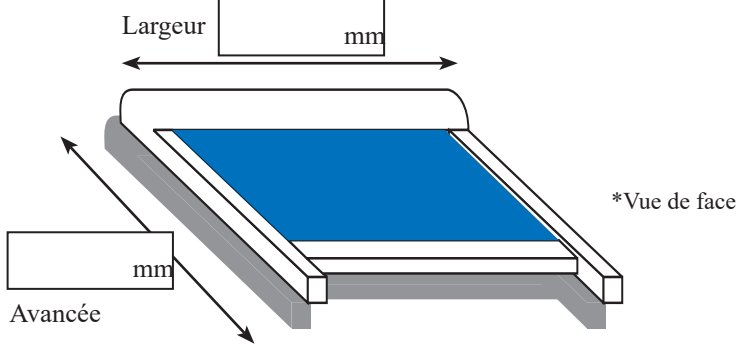

Dimensions 2 travées - 1 moteur

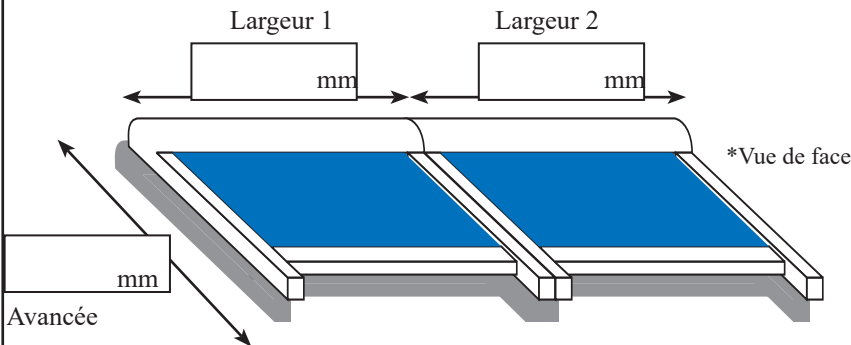

Couleur Armature

RAL 9010 blanc RAL 8019 marron

Autre

MANŒUVRE

Droite

Gauche

Autre moteur(s) :

TOILE

Dickson Telya Tibelly

Soltis 86 Dickson Sunworker

Référence :

SUPPORTS

Supports coulisses

simple travée

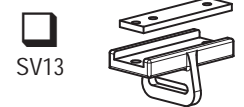
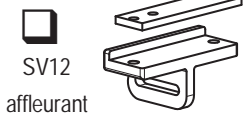

doubles travées

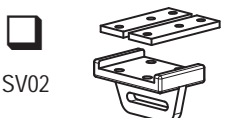

Supports sur épis

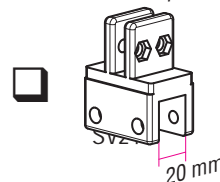
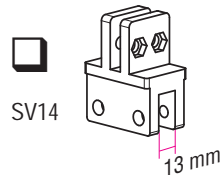
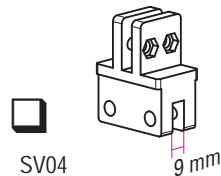

Supports à plat

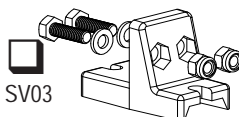
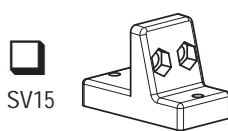

Supports universel coulisse/ épis / plat simple travée

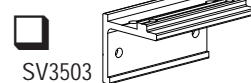
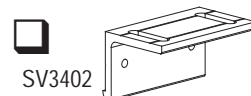

réhausse

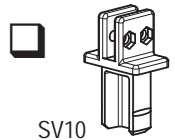

épis

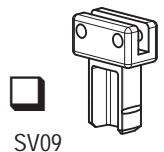

plat

